

Fire Alarm Control Panel

AH-03312 Family

Operating Manual

CONTENTS

System Description

1	System Characteristics.....	1
2	Fire Signal Receiving Flowchart.....	2
2.1	Fire Alarm System.....	2
2.2	Fire Signal Receiving Flowchart.....	3
3	Fire Signal Receiving Board's Description.....	4
3.1	LED Indicators.....	4
3.2	Keypad Switches.....	4
4	Wiring Diagram Description.....	6
4.1	Zone Wiring.....	7
4.2	Alarm Bell Wiring.....	7
4.3	24V DC Output Wiring.....	8
4.4	Dialler Relay Output Wiring.....	8
4.5	Fire/Fault Connection's Relay Output.....	8
4.6	Annunciator Wiring.....	9
4.7	AC Power Connection	9
5	Operating Instructions.....	10
5.1	Information Function Screen.....	10
5.2	Menu Description.....	10
1.	Zone Status Disp.....	10
2.	Memory Data Disp.....	11
3.	Main Switch.....	11
4.	Zone Disable.....	
5.	Memory Data Delete.....	
6.	Set Up.....	
6	Maintenance Instructions.....	
7	Trouble Shooting.....	
8	General Specifications.....	

AH-03312 System Characteristics

1. CE approved.
2. Model range from 1 to 32 zones.
3. Each zone has a separate disable function.
4. Panel door protection design for 32L cabinet.
5. Protective key switch disables all the panel switches for 4L and 8L cabinets.
6. AC power supply has EMI. (Electromagnetic Interference)
7. Protection against voltage spikes up to 2.5KV.
8. Fire Alarm NO, NC, COM and Fault NO, NC, COM Output contact points.
9. Double sets of sounder contacts.
10. Automatic telephone dialer feature.
11. Fire Relay Output contacts and Fault Relay Output contacts.
12. Fire/Fault Relay Output to each Zone. (Option)
13. Extinguishing facility. (Option)
14. LCD screen 24 by 2. (Option)
15. Long-term or temporary silencing feature.
16. Sounder short circuit or disconnection detection.
17. PCB disconnected detection. (Used on panels monitoring more than 8 zones.)
18. Microprocessor-base design.
19. Digital Signal Design.
20. Switch membrane provides longer service and is waterproof, dust resistant and easy to clean.

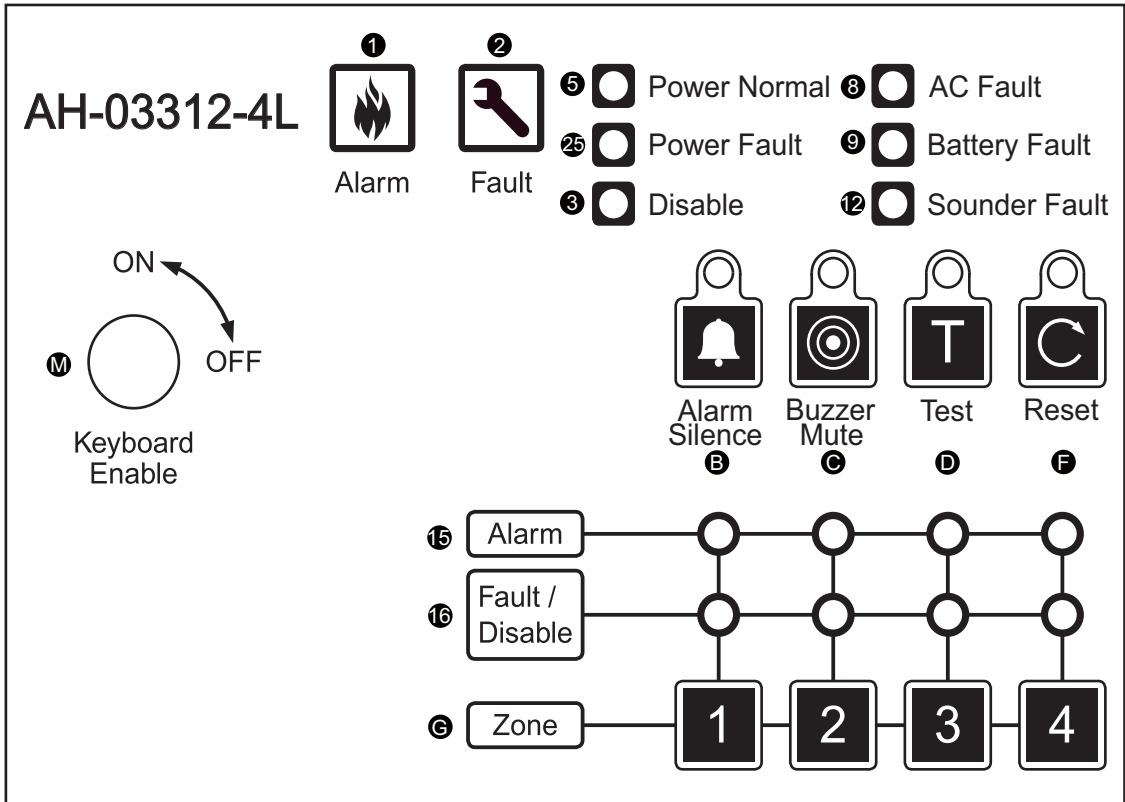

- | | |
|----------------------------------|---------------------------|
| 1. Fire Alarm Indicator | B. Alarm Silence Switch |
| 2. Fault Indicator | C. Buzzer Mute Switch |
| 3. Zone Disable Indicator | D. Test Switch |
| 5. Power Normal Indicator | F. Reset Switch |
| 8. AC Fault Indicator | G. Zone Disable Switch |
| 9. Battery Fault Indicator | M. Keyboard Enable Switch |
| 12. Sounder Fault Indicator | |
| 15. Zone Alarm Indicator | |
| 16. Zone Fault/Disable Indicator | |
| 25. Power Fault Indicator | |

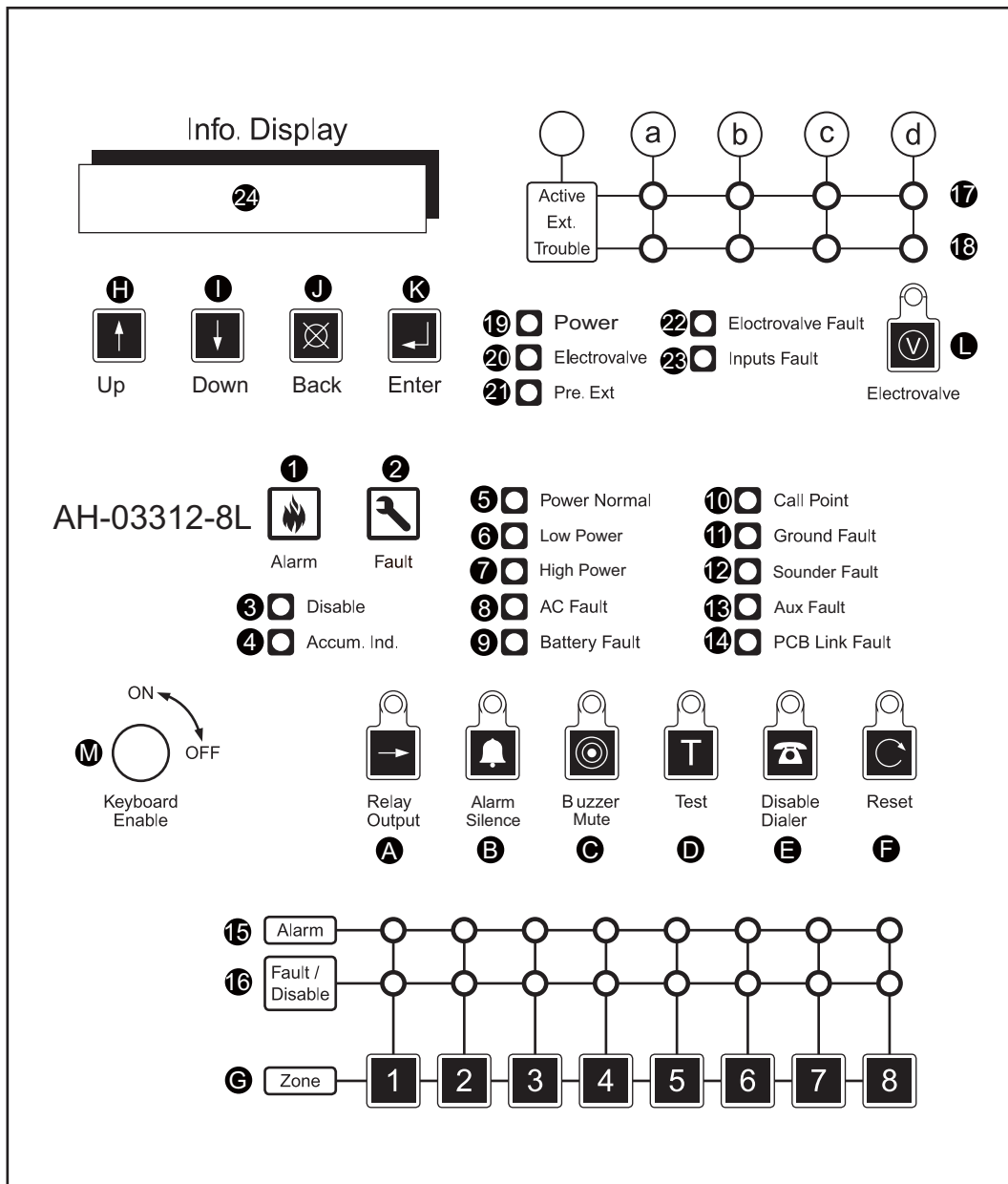

- | | | |
|---------------------------------|----------------------------------|--------------------------------|
| 1. Fire Alarm Indicator | 13. Aux Fault Indicator | A. Relay Output Switch |
| 2. Fault Indicator | 14. PCB Link Fault Indicator | B. Alarm Silence Switch |
| 3. Zone Disable Indicator | 15. Zone Alarm Indicator | C. Buzzer Mute Switch |
| 4. Accumulation Indicator | 16. Zone Fault/Disable Indicator | D. Test Switch |
| 5. Power Normal Indicator | 17. Ext. Zone Active Indicator | E. Disable Dialer Switch |
| 6. Low Power Indicator | 18. Ext. Zone Trouble Indicator | F. Reset Switch |
| 7. High Power Indicator | 19. Power Indicator | G. Zone Disable Switch |
| 8. AC Fault Indicator | 20. Electrovalve Indicator | H. Up Switch |
| 9. Battery Fault Indicator | 21. Pre. Ext. Indicator | I. Down Switch |
| 10. Manual Call Point Indicator | 22. Electrovalve Fault Indicator | J. Back Switch |
| 11. Ground Fault Indicator | 23. Inputs Fault Indicator | K. Enter Switch |
| 12. Sounder Fault Indicator | 24. Information Display | L. Electrovalve Disable Switch |
| | | M. Keyboard Enable Switch |

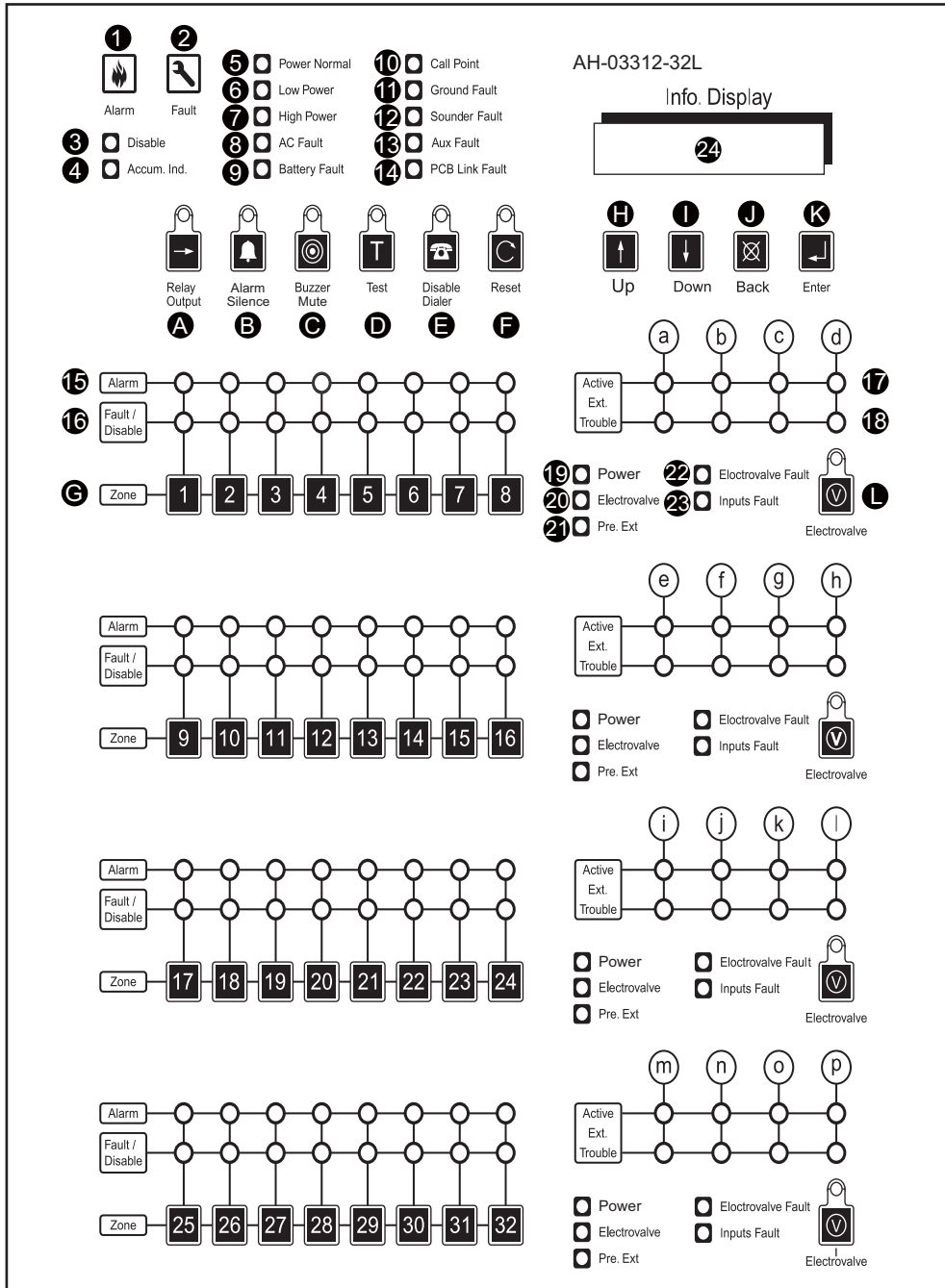

- | | | |
|---------------------------------|----------------------------------|--------------------------------|
| 1. Fire Alarm Indicator | 13. Aux Fault Indicator | A. Relay Output Switch |
| 2. Fault Indicator | 14. PCB Link Fault Indicator | B. Alarm Silence Switch |
| 3. Zone Disable Indicator | 15. Zone Alarm Indicator | C. Buzzer Mute Switch |
| 4. Accumulation Indicator | 16. Zone Fault/Disable Indicator | D. Test Switch |
| 5. Power Normal Indicator | 17. Ext. Zone Active Indicator | E. Disable Dialer Switch |
| 6. Low Power Indicator | 18. Ext. Zone Trouble Indicator | F. Reset Switch |
| 7. High Power Indicator | 19. Power Indicator | G. Zone Disable Switch |
| 8. AC Fault Indicator | 20. Electrovalve Indicator | H. Up Switch |
| 9. Battery Fault Indicator | 21. Pre. Ext. Indicator | I. Down Switch |
| 10. Manual Call Point Indicator | 22. Electrovalve Fault Indicator | J. Back Switch |
| 11. Ground Fault Indicator | 23. Inputs Fault Indicator | K. Enter Switch |
| 12. Sounder Fault Indicator | 24. Information Display | L. Electrovalve Disable Switch |

Indicators

1. Fire Alarm Indicator: A red light indicates the Fire Alarm Control Panel has received a fire signal.
2. Fault Indicator: A yellow light indicates a fault in the fire alarm system.
3. Zone Disable Indicator: A yellow light indicates a zone has been disabled.
4. Accumulation Indicator: When the Fire Alarm Control Panel is turned on, it will scan the circuit boards. The number of times the yellow light flashes indicates the number of circuit boards being scanned. The buzzer will sound twice to indicate the scan is complete. (Used on panels monitoring more than 8 zones.)
5. Power Normal Indicator: A green light indicates the Fire Alarm Control Panel is in normal condition.
6. Low Power Indicator: A yellow light indicates the AC or DC power supply is 15% lower than the required voltage.
7. High Power Indicator: A yellow light indicates the AC or DC power supply is 15% higher than the required voltage.
8. AC Fault Indicator: A yellow light indicates a break in the AC power supply.
9. Battery Fault Indicator: A yellow light indicates short circuit or wire-break in the Fire Alarm Control Panel's battery wires.
10. Manual Call Point Indicator: A red light indicates the Fire Alarm Control Panel is receiving a signal from a manual call point. (Option)
11. Ground Fault Indicator: A yellow light indicates a short circuit to the casing or ground.
12. Sounder Fault Indicator: A yellow light indicates a short circuit or wire-break to the sounder.
13. Aux Fault Indicator: A yellow light indicates a malfunction in the DC24V power supply to outside devices.
14. PCB Link Fault Indicator: A yellow light indicates a circuit board has become disconnected.
15. Zone Alarm Indicator: A red light indicates the Fire Alarm Control Panel has received a fire signal from this zone. The red light goes off after resetting the control panel.
16. Zone Fault/ Disable Indicator: A steady yellow light indicates the Fire Alarm Control Panel has received a signal that a zone has short circuit or disconnection. The yellow light goes off after the zone is well connected. A flashing yellow light indicates a zone has been disabled.
17. Ext. Zone Active Indicator: A red light indicates the system has confirmed an alarm condition.
18. Ext. Zone Trouble Indicator: A yellow light indicates short circuit or disconnection in an extinguishing zone.
19. Power Indicator: A green light indicates a normal power status for the extinguishing function.
20. Electrovalve Indicator: When the checking is complete, the red light indicates the gas is being released.
21. Pre. Ext. Indicator: A red light indicates the checking count down is in progress.
22. Electrovalve Fault Indicator: A yellow light indicates disconnection or short circuit. (Option)
23. Input Fault Indicator: A yellow light indicates a faulty connection to an external device.
24. Informational Display: It provides a read-out of system conditions.
25. Power Fault Indicator: A yellow light indicates the AC or DC power supply is 15% lower or higher than the required voltage.

Switches

- (A) Relay Output Switch: If there is an alarm or a fault in the system, pressing this switch will disable the fire and fault relay output and the indicator will go on. Pressing the switch again will restore the relay output and the indicator will go out.
- (B) Alarm Silence Switch: If there is an alarm or a fault in the system, pressing this switch will disable the relay output to the bells and the indicator will go on. When a new signal is received, the bell function will be restored. If the switch is pressed again, the bell function will be restored and the indicator will go out. If the switch is pressed for more than 2 seconds, the indicator will flash and the bells will remain disabled despite any new signals. (Used on panels monitoring more than 8 zones.)
- (C) Buzzer Mute Switch: If there is an alarm or fault in the system, pressing this switch will disable the buzzer and the indicator will go on. When a new signal is received, the buzzer function will be restored. If the switch is pressed again, the buzzer function will be restored and the indicator will go out. If the switch is pressed for more than 2 seconds, the indicator will flash and the buzzer will remain disabled despite any new signals. (Used on panels monitoring more than 8 zones.)
- (D) Test Switch: Use it to check that the indicators and buzzer are in a normal status. After pressing it, all the indicators will shine and the buzzer will sound. After five seconds, the fire alarm control panel will automatically return to pre-test condition. If a new fire alarm signal is received during test mode, the test mode will be interrupted and the fire alarm control panel will respond to the signal.
- (E) Disable Dialer Switch: Pressing this switch during a fire alarm condition will disable the automatic dialer. The indicator will shine. Pressing this switch a second time will enable the dialer and the indicator will go out.
- (F) Reset Switch: Pressing this switch resets the panel.
- (G) Zone Disable Switch: When the Zone Disable Switch is pressed, the Zone Alarm Indicator goes out and Zone Fault/ Disable Indicator flashes yellow. When the Zone Disable Switch is pressed again, the Zone Alarm Indicator shines red and Zone Fault/ Disable Indicator goes out.
- (H) Up Switch: Pressing this switch shows the previous item on the page. It can also be used to change the time and passwords by increasing the value progressively.
- (I) Down Switch: Pressing this switch shows the next item on the page. It can also be used to change the time and passwords by decreasing the value progressively.
- (J) Back Switch: Pressing this switch shows the previous page of the display. When changing the time and passwords, pressing this switch will shift control to the previous decimal place.
- (K) Enter Switch: Pressing this switch shows the next page of the display. When changing the time and passwords, pressing this switch will shift control to the next decimal place.
- (L) Electrovalve Disable Switch: During the countdown, pressing this switch disables the electrovalve and the indicator shines red.
- (M) Keyboard Enable Switch: When the switch is turned on, the keyboard is enabled.

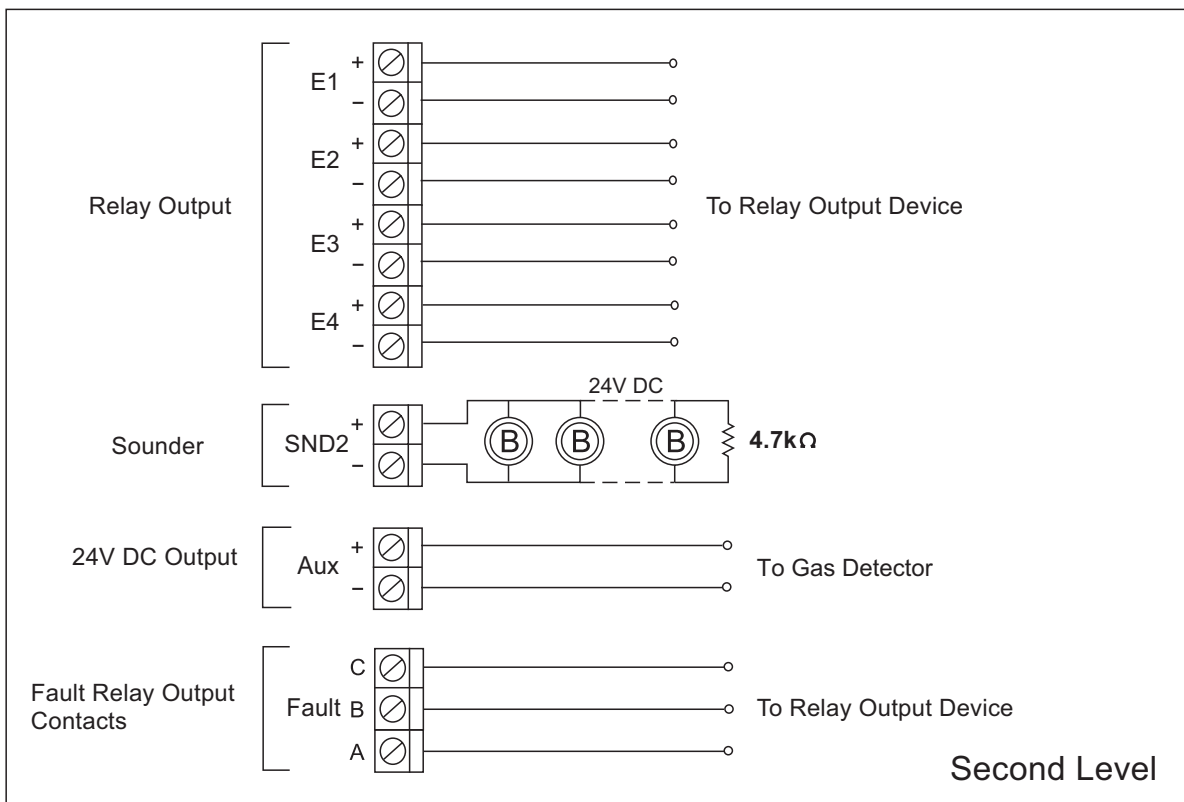
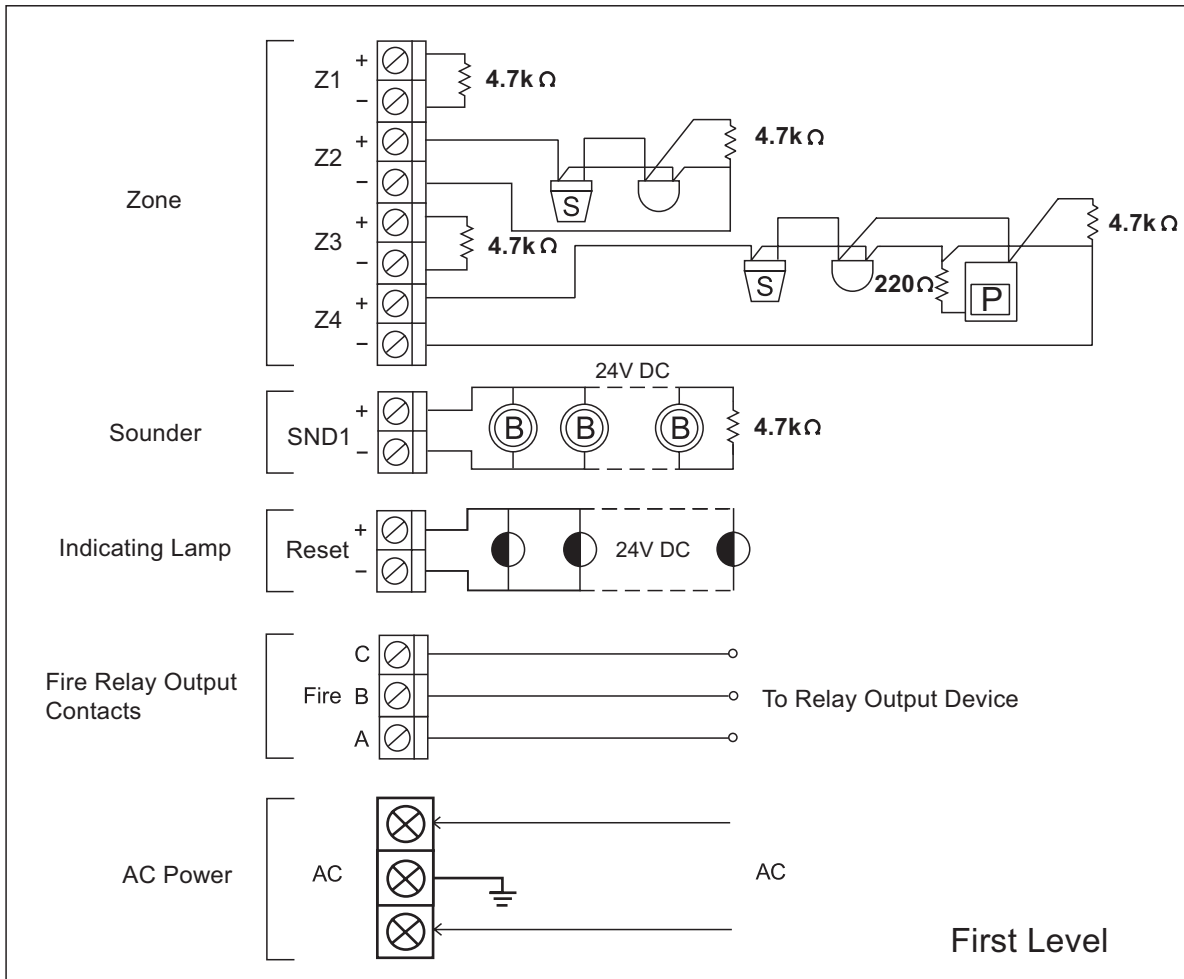

AH-03312-8L

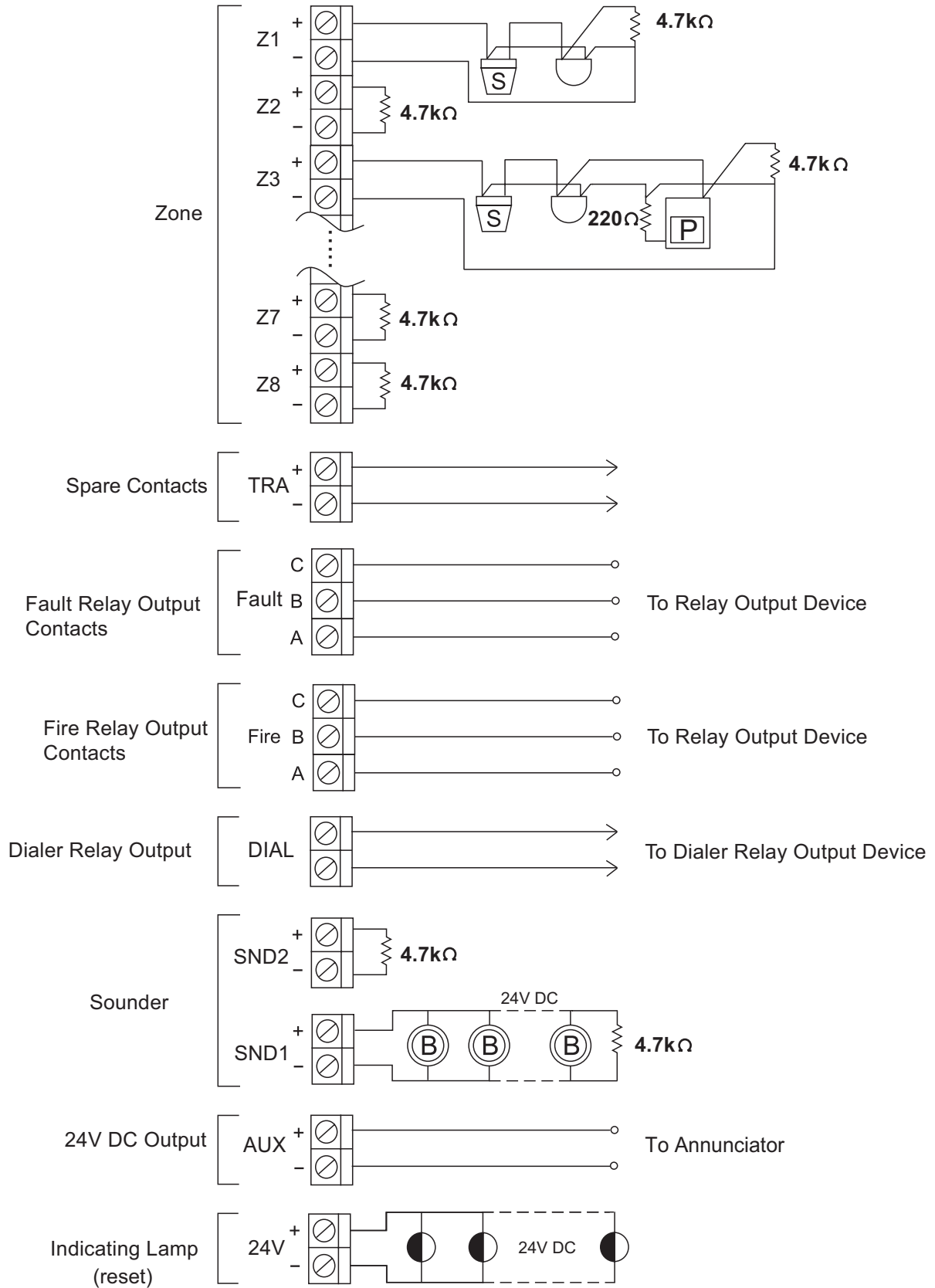

AH-03312-32L

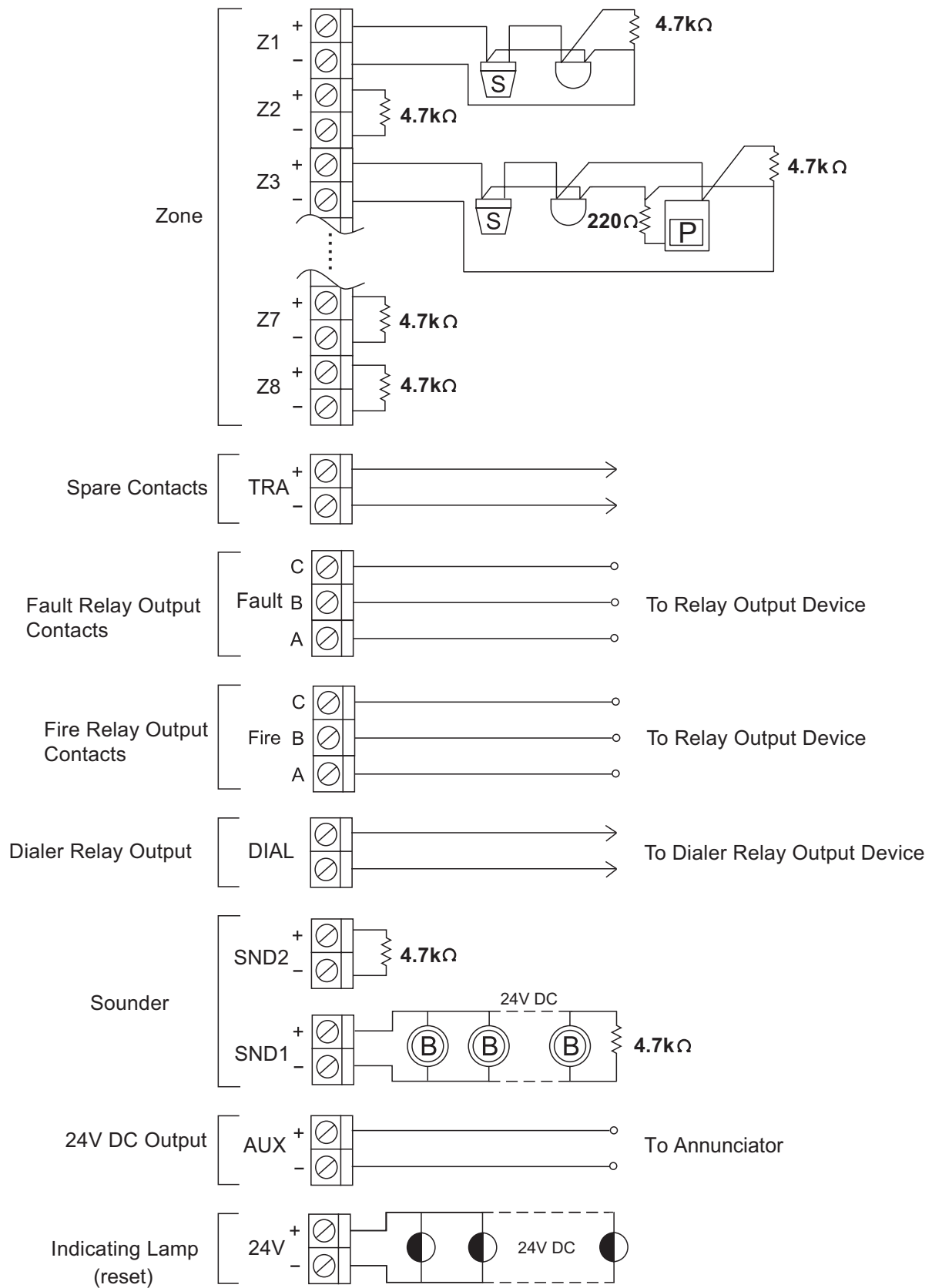

(1) Zone Wiring:

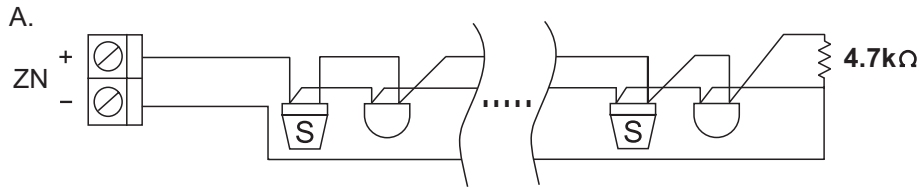

Wiring Diagram A. Recommended connection. The maximum number of smoke detectors to be connected is 30 for each zone (not including the mechanic-type heat detectors).

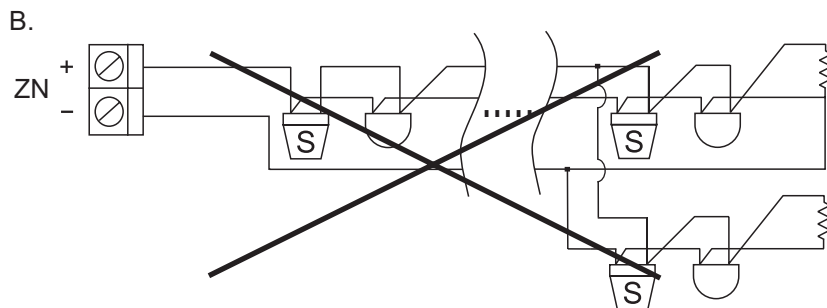

Wiring Diagram B. Improperly connected. Do not connect a detector or a end of line resistor in parallel with another detector.

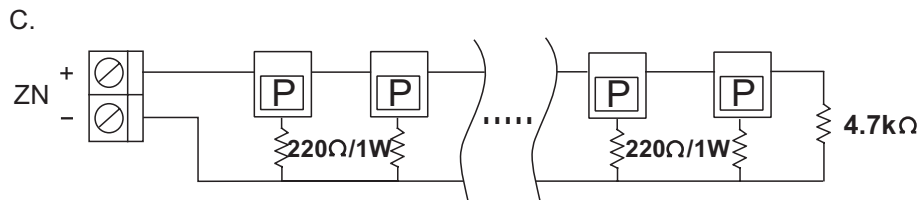

Wiring Diagram C. When connecting a manual call point to a zone, please connect a 220 ohm resistor and install the 4.7K ohm end of line resistor.

(2) Area Bell Wiring:

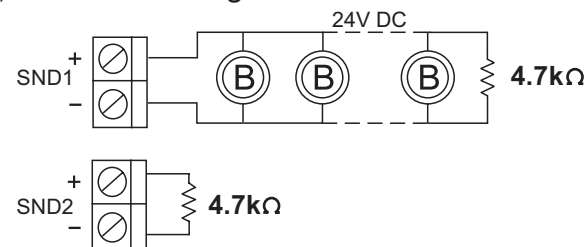

Fire alarm control panel is equipped with two set of Area Bells contacts. When connecting one set of bell contacts, be sure to connect the end of line resistor to avoid bell malfunction.

Install the 4.7K ohm resistor across the unused bell contacts as well.

(3) 24V DC Output Wiring:

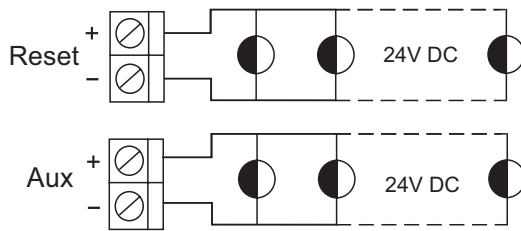

The contacts marked “24V” are controlled by the reset switch but the contacts marked “AUX” are not. When connecting the indicating lamp to the contacts, connect the red wire to the “+” and the black wire to the “-” contact.

(4) Dialer Relay Output Wiring:



This contacts are NO and COM. When there is a fire alarm, the signal will go through the telephone line.

(5) Fire/Fault Relay Output Contacts:

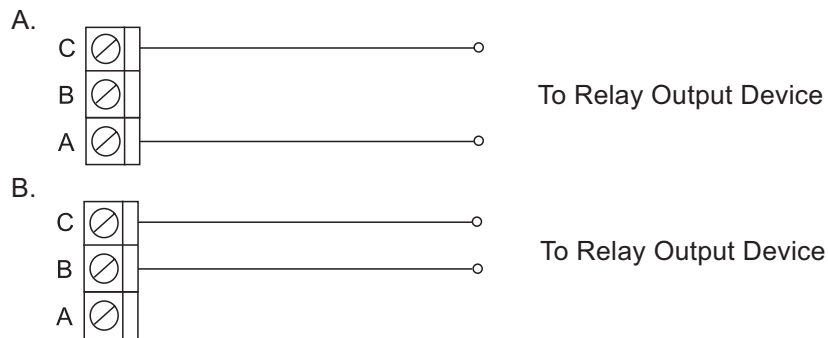

In picture A shows N.O. connection
In picture B shows N.C. connection.

(6) Fire/Fault Relay Output to Each Zone (Option) :

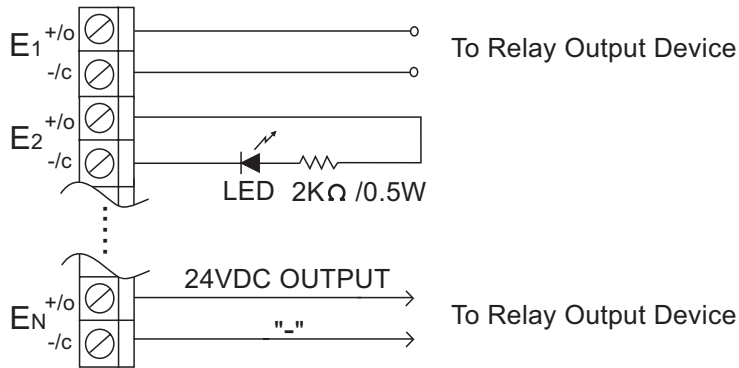

E1: Voltage Free contacts.

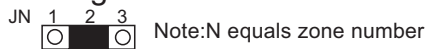

E2: Connect a black wire from the “-” contact to the side of the LED.

Then connect a red wire from the “+” contact to a 2K ohms resistor and connect the 2K ohms resistor to the “+” side of the LED.

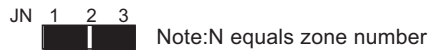

EN: Connect a red wire from the “+” contact to the “+” side of the device.

Connect a black wire from the “-” contact to the “-” side of the device.

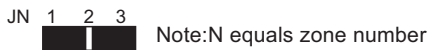

*Above 3 wiring methods could be used separately or mixed.

(7) Gas Relay (Option) :

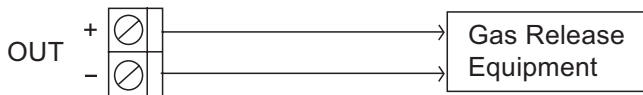

Connect “+ OUT” contact with a red wire to the “+” side of the gas release control device and connect the “- OUT” contact with a black wire to the “-” side of the gas release control device.

(8) Stop Gas Release (Option):

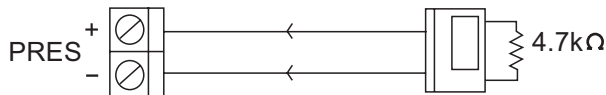

Connect “+ PRES” contact with a red wire to the “+” side of the stop gas release device and connect the “- PRES” contact with a black wire to the “-” side of the stop gas release device. Please install the 4.7K ohm end of line resistor.

(9) Annunciator Wiring (Used on panels monitoring more than 8 zone):

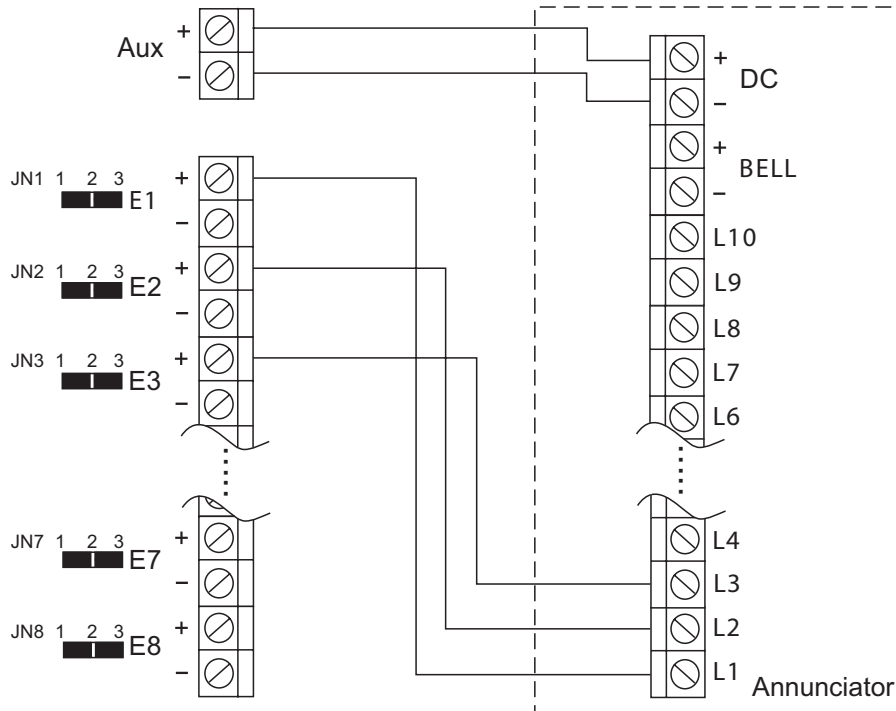





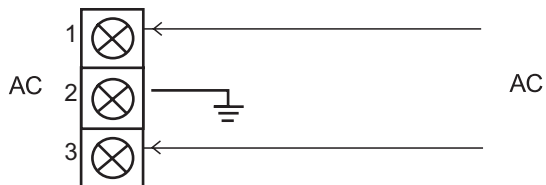

Connect panel's "+ AUX" contact to annunciator's "+ DC" contact.
 Connect panel's "- AUX" contact to annunciator's "- DC" contact.
 Connect panel's "+ E1" contact to annunciator's "L1" contact ...and so on.

(10) AC Power Connection:



Connect the AC power supply wires to contacts 1 and 3.
 Connect the ground wire to contact 2.

Operating Instructions

- (1) Fire Surveillance: Ensure the AC power source is within +/- 15% of the nominal value. After installation of fire alarm control panel and connected devices is complete, please connect to the power source. The “Power Normal” indicator on the control panel will shine and the system will begin to monitor the building.
- (2) Fire Alarm: When a detector in any zone is activated or a manual call point is pressed, a fire signal is sent. Both the “Fire Alarm” indicator and the “Zone Alarm” indicator will light up and the buzzer and area bell will sound.
 - a. To silence the buzzer: Pressing the “ Buzzer Mute” switch will disable the buzzer and the indicator will go on. When a new signal is received, the buzzer function will be restored. If the switch is pressed again, the buzzer function will be restored and the indicator will go out. If the switch is pressed for more than 2 seconds, the indicator will flash and the buzzer will remain disabled despite any new signals until the switch is pressed again. (Used on panels monitoring more than 8 zones.)
 - b. To silence the area bell: Pressing the “ Alarm Silence” switch will disable the relay output to the bells and the indicator will go on. When a new signal is received, the bell function will be restored. If the switch is pressed again, the bell function will be restored and the indicator will go out. If the switch is pressed for more than 2 seconds the indicator will flash and the bells will remain disabled despite any new signals until the switch is pressed again. (Used on panels monitoring more than 8 zones.)
- (3) Test: Pressing the “ Test” switch, all the indicators will shine and the buzzer will sound. After five seconds, the fire alarm control panel will automatically return to pretest condition. If a new fire alarm signal is received during test mode, the test mode will be interrupted and the fire alarm control panel will respond to the signal.
- (4) Stop Relay Output: If there is an alarm or a fault in the system, pressing this “ Relay Output” switch will disable the relay output and the indicator will go on. Pressing the switch again will restore the relay output and the indicator will go out. (Used on panels monitoring more than 8 zones.)
- (5) Disable Dialer Relay Output: Pressing this “ Disable Dialer” switch during a fire alarm condition will disable the automatic dialer. The indicator will shine. Pressing this switch a second time will enable the dialer and the indicator will go out. (Used on panels monitoring more than 8 zones.)
- (6) Reset: After a fire alarm, the Alarm indicator and zone Alarm indicator will remain lit. To reset the panel press this “ Reset” switch. The reset indicator will light up and after a 5-second delay, the system will be restored to surveillance status.

(7) Fault Alarm: The panel has a zone fault disable function. If a zone has a fault or disconnection, the Fault and the zone Fault/ Disable indicators will light up. After the fault has been repaired, the indicators will go out.



To silence the buzzer: Pressing the "🔇 Buzzer Mute" switch will disable the buzzer and the indicator will go on. When a new signal is received, the buzzer function will be restored. If the switch is pressed again, the buzzer function will be restored and the indicator will go out. If the switch is pressed for more than 2 seconds, the indicator will flash and the buzzer will remain disabled despite any new signals until the switch is pressed again. (Used on panels monitoring more than 8 zones.)

(8) Standby Power: This control panel is equipped with a backup battery. When the AC power is interrupted, the battery will supply power. The buzzer will sound and the AC Fault and Fault indicators will light up.

(9) Zone Disable: If you would like to disable the zone relay output when there is a fire, press the relevant "1" switch to disable the zone. The relevant Fault/ Disable indicator will flash and the Disable indicator will light up.

* Example: First Zone 1

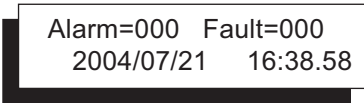
(10) Informational Function Screen (Option):

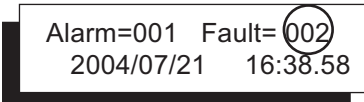
1.  Fire Alarm Control Panel surveillance status.
2.  When the control panel receives a fire alarm signal, the screen shows the total number of alarms.
3.  When the control panel receives a fault signal, the screen shows the total number of faults.

a. Check Alarm Data:

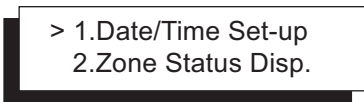
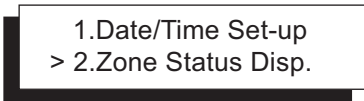
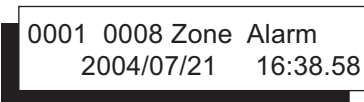
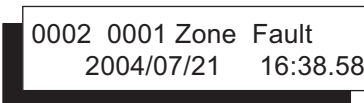
1.  Press the "Enter" switch to see more details on each item.
2.  Press the "Down" switch to select the next item and press the "Enter" switch to see the details.
3.  The number in the upper left-hand corner is the sequence of the signal. For example, "0001" is the first signal. The number in the upper middle screen shows the zone number. The upper right-hand corner shows the type of signal, Alarm or Fault. The lower screen displays the time and date of the event.
4.  Press the "Down" switch to check the next event. Press "Back" to return to the selection list.

b. Set-Up Date/Time :

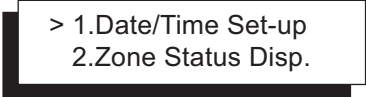
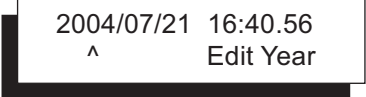
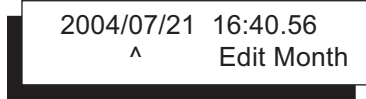
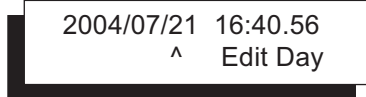
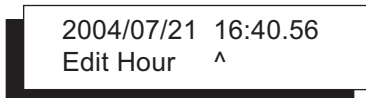
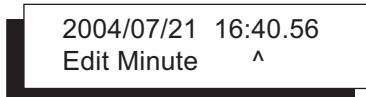
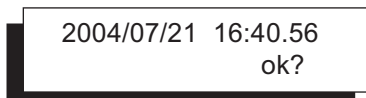
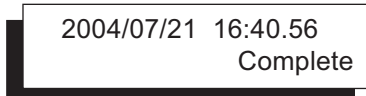
1.  Move the cursor to item 1-Date/Time Set-up. Press the "Enter" switch to open the Date/Time Set-up.
2.  The lower right screen shows the editing item (Edit Year). Press "Up" switch to raise the value of the digit. Press "Down" switch to lower the value of the digit.
3.  After setting the year, press the "Enter" switch to edit month. Use the "Back" switch to move to a previous digit.
4.  After setting the month, press the "Enter" switch to edit day. Use the "Back" switch to move to a previous digit.
5.  After setting the day, press the "Enter" switch to edit hour. Use the "Back" switch to move to a previous digit.
6.  After setting the hour, press the "Enter" switch to edit minute. Use the "Back" switch to move to a previous digit.
7.  Press "Enter" to complete the date and time setup. Use the "Back" switch to move to a previous digit.
8.  After setup is completed, the display returns to the selection list.

c. Check Memory Data:

1. 

Press the "Down" switch to move to item 3 - Memory Data Disp. Press "Enter" switch to open the Memory Data Disp.

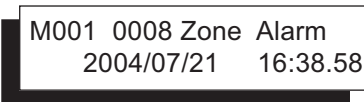
2. 

In the upper left - hand corner is the number of the event. (M001 ~ 255) The highest number shows the most recent event. The upper middle screen shows the zonenummer. The upper right-hand shows the type of signal. The lower screen displays the time and date of the event.

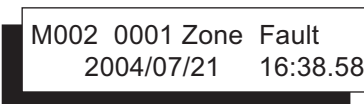
3. 

Press "Up" switch to check the previous event.
Press the "Down" switch to check the next event.
Press "Back" to return to the selection list.

d. Delete Memory Data:

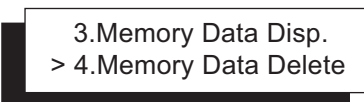
1. 

Press the "Down" switch to move the cursor to item 4-Memory Data Delete. Press the "Enter" switch to open the Memory Data Delete.

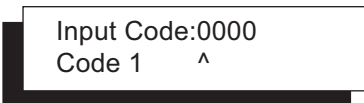
2. 

To delete the memory, input a 4 digit code, starting with the left digit (code1). Press "Up" switch to raise the value of the digit. Press "Down" switch to lower the value of the digit.

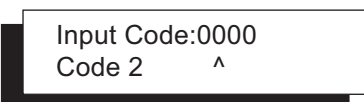
3. 

Press "Enter" switch to move the cursor to the next digit. Use the "Back" switch to move to a previous digit.

4. Input Code:0000
ok?

After the code is finished, press "Enter" switch to delete the memory. Use the "Back" switch to return to the 4th digit (code 4).

5. Input Code:0000
Data Deleting

After deleting, the display returns to the the selection list.

e.Security Code Reset:

1. > 5.Security Code Set
6.Backlight Timer

Press the "Down" switch to move the cursor to item 5-Security Code Set. Press the "Enter" switch to open the Security Code Set.

2. Input Login Code:0000
Input Code 1 ^

To reset the security code, input the 4 digit original security code, starting with the left digit (code1). Press "Up" switch to raise the value of the digit. Press "Down" switch to lower the value of the digit.

3. Input Login Code:0000
ok?

Press "Enter" switch to move the cursor to the next digit. Use the "Back" switch to move to a previous digit.

4. Input Set Code:0000
Input Code 1 ^

Input a new 4-digit security code.

5. Input Set Code:0000
ok?

After the code is finished, press "Enter" switch to complete the code setting. Use the "Back" switch to return to the 4th digit (code 4).

6. Input Set Code:0000
Complete

After setting up, the display returns to the selection list.

f. Set Backlight Timer:

1.  5.Security Code Set
> 6.Backlight Timer

Press the "↓ Down" switch to move to item 6 Backlight Timer. Press "↵ Enter" switch to open the Backlight Timer.

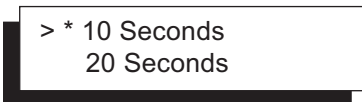
2.  > * 10 Seconds
20 Seconds

Use the "↑ Up" or "↓ Down" switch to move the cursor to the selection you prefer. To make the selection, press "↵ Enter" switch. Press the "⏪ Back" switch to return to the selection list.

Installation Location

Please refer to your own national fire alarm system standard to carry out installation.

Maintenance Instructions

- (1) Normal Status:
 - a. In normal operating status, the Power Normal indicator will shine.
 - b. When AC power fails, the backup battery supplies power. The Fault and AC Fault indicators will shine and the buzzer will sound. The system can continue monitoring for 72 hours and sound an alarm for 30 minutes.
- (2) Maintenance:

If the equipment is installed in a public place, maintenance and testing will disturb people. Be sure to inform them beforehand. If the equipment is found to be faulty, it must be fixed and maintained regularly. Check the current at the power supply of the fire alarm system, the voltage of the backup battery and discharge time of the backup battery. Press the Test switch to check that all the indicators shine and buzzer sounds. Check to see whether any detectors are defective and check whether manual call points are defective or have a broken glass shield. Check the whole wiring system for faults. Check for any ground faults at the AC input contacts. Applying 250V AC should produce a 20 M ohms resistance.

Trouble Shooting

- (1) Examine Indicators: This system is composed of several devices and it will be affected by defective and improper use of detectors, wiring, bells, and manual call points.
 - a. Use a multi-meter to test the voltage at the AC input contacts.
 - b. Check that the Power Normal indicator shines.
 - c. See whether any fuses are burned out.
 - d. Check that the external devices and wiring are normal.
- (2) Fuse Function: The fuses in the panel have a special protective function, so do not use unspecified or poor quality products. Faulty external wiring and poor quality products will make fuses burn out.
 - a. AC: Normal power 220V AC fuse (2A).
 - b. BATT: Backup battery fuse (2A).
 - c. SND1 and SND2: Bell fuse (Auto-reset).
 - d. AUX: Output fuse (Auto-reset).
 - e. 24 V DC: DC power output fuse (Auto-reset).
- (3) Reasons for Burned Out Fuses and Inspection Notes:
 - a. AC power fuse burn out: Check whether the applied power is over the specified value and if the specification is correct. (Using a fuse lower than specified will make the fuse burn out)
 - b. Backup battery fuse burn out: Check whether the polarity of the contacts is right.
- (4) False Bell Alarm: The improper wiring can make the bell sound when no alarm signal is given. Please remove the external wiring and then use a multi-meter to test the bell's contacts which shouldn't give 24V DC reading. If it meets the mentioned requirement, please check the external wiring.

- (5) Zone Abnormal Status (Zone Fault/Disable Indicator ON): According to the statistic, most zone faults are due to incorrect wiring. Some other reasons for fault are improper use and misconnection to contacts.
- Inspection Notes are as below:
- a. Check the unused zones to see if the end of line resistors have fallen off.
 - b. Disconnect the zone wiring and connect a 4.7K ohms resistor across the contacts. The fault signal should disappear.
 - c. If above conditions are met, the control panel is in normal condition. The fault signal is being caused by an external wiring fault. After repairing the external wiring, you may connect the wiring to the control panel again.
 - d. Check whether the external wiring is short circuited or disconnected, detectors have fallen off or loosened or are defective, and the end of line resistor in detectors have fallen off or was not installed.
 - e. Use a multi-meter to check that the resistance across the L(Z+) and LC(Z-) contacts is about 4.7K ohms.
 - f. Disconnect the wires leading to the contacts L and LC. Check the voltage across the two wire is 0 volts.
- (6) Zone Alarm and Alarm Indicators ON: Inspection notes:
- a. Disconnect the faulty zone and check the resistance across the L and LC wires is about 4.7K ohms.
 - b. Disconnect the faulty zone, the Zone Alarm indicator will go out and the Zone Fault/Disable indicator will light up. If you would like to make the Zone Faulty indicator go off, you should install the end of line resistor across the L(Z+) and LC(Z-) contacts of the Zone. After repairing the wiring, please reconnect the external wiring.

Housing Specifications

AH-03312-4L

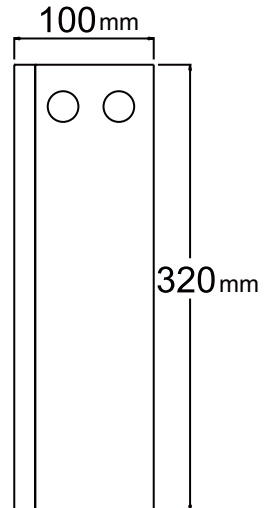
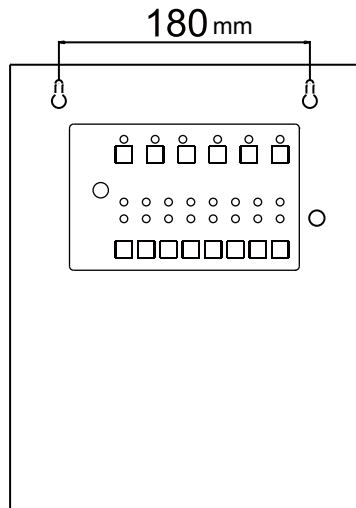
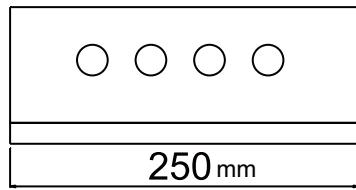

AH-03312-8L

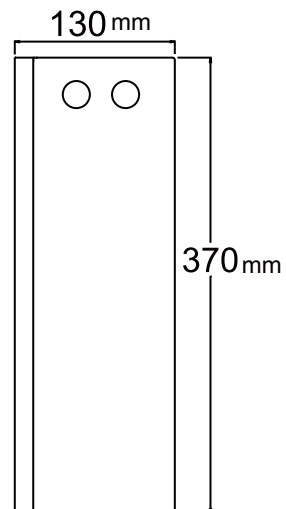
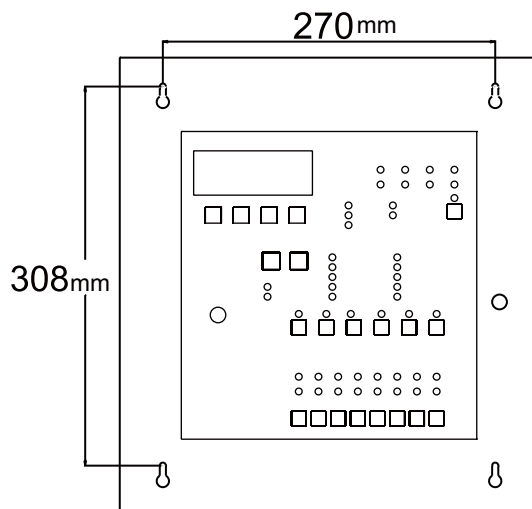
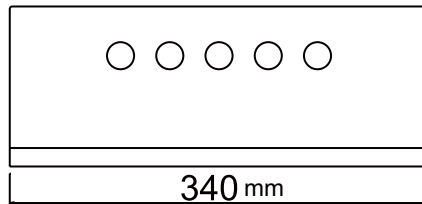

Housing Specifications

AH-03312-32L

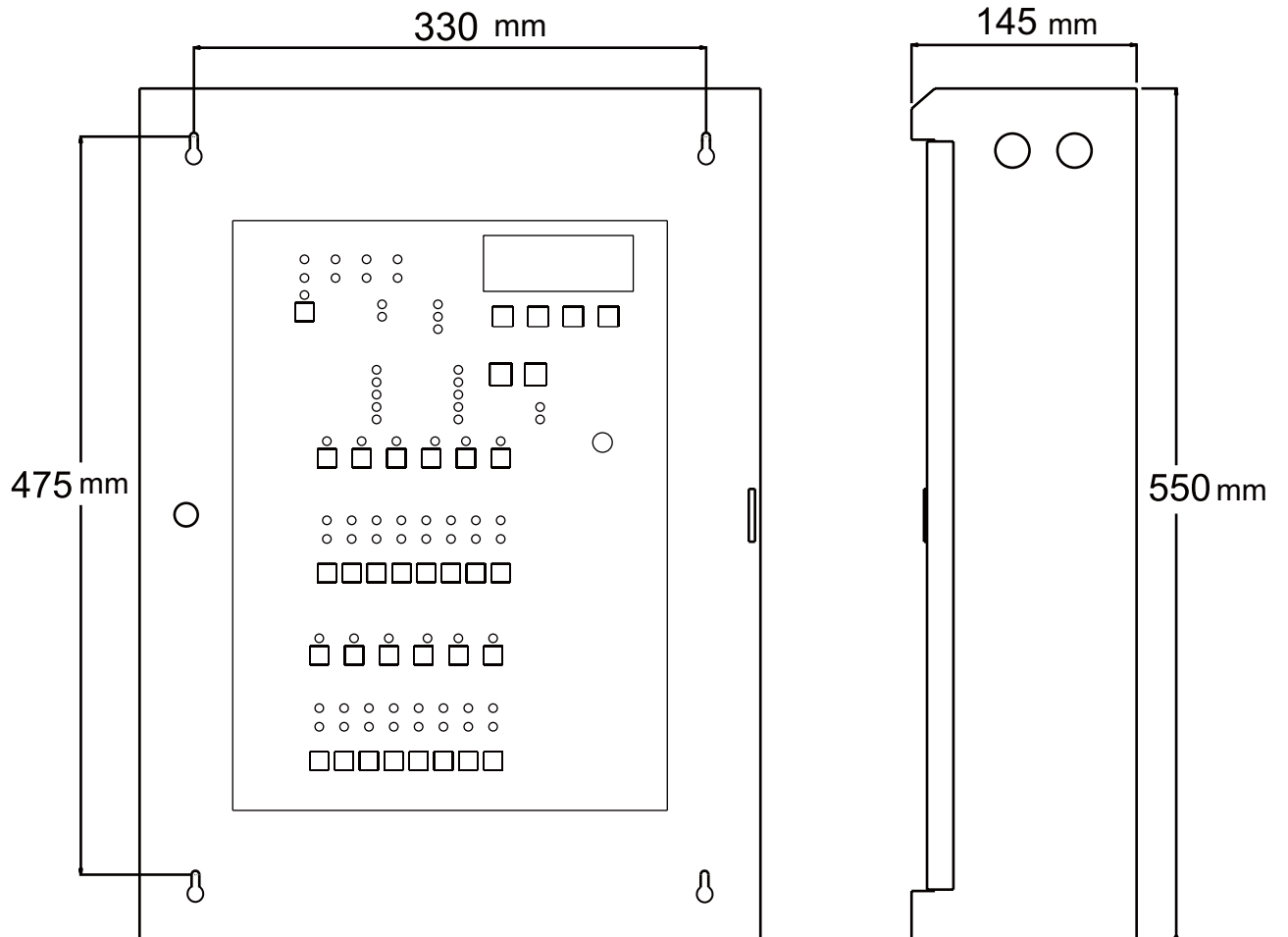
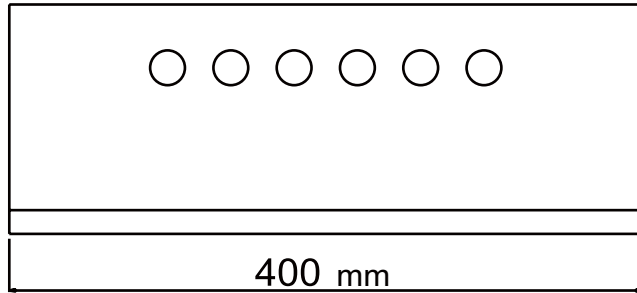

General Specifications

Main Power Source

Input Voltage.....	220V \pm 15%
Frequency	50Hz
Fuse.....	2A

*Voltage and frequency varies in different regions.

Standby Power

Battery Consumption	4L/ 8L/ 32L:24V/4Ah/7Ah/12Ah
Charge Voltage.....	27V/1.2Ah
Fuse.....	2A

Single Loop

Voltage.....	20V
Terminal Resistor	4.7K Ω
Maximum sensor's connection (Smoke Detector).....	30
Manual Call Point Resistance.....	220 Ω /1W

Area Sounder Output

Voltage.....	20-30 V
Maximum Supply Current.....	depending on transformer
Terminal Resistor	4.7K Ω
Fuse	2A

Relay Output

Maximum Voltage	AC 250V/DC 30V
Maximum Supply Current	2A(Auto-reset)

AUX Output Voltage

Voltage.....	20-30 V
Maximum Supply Current.....	depending on transformer
Fuse	2A(Auto-reset)

24V DC Output Voltage

Voltage.....	20-30 V
Maximum Supply Current.....	depending on transformer
Fuse.....	2A(Auto-reset)

Connecting Cable

Cable's Semi-Diameter	1.5 ² mm max
Maximum Supply Current.....	2A

Ambient Temperature

Operating Temperature.....	-7 $^{\circ}$ C-45 $^{\circ}$ C
Storage Temperature	-10 $^{\circ}$ C-70 $^{\circ}$ C



AH-03312 Fire Alarm Control Panel