

FIRE ALARM CONTROL PANEL



QP Family Fire Alarm Control Panel

Operating Manual

Model # QP112, QP212, QP412



Descriptions

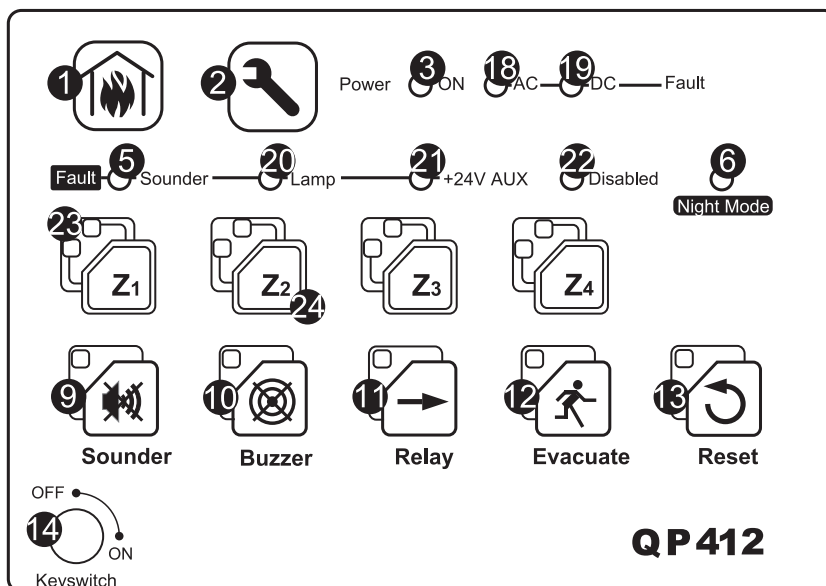
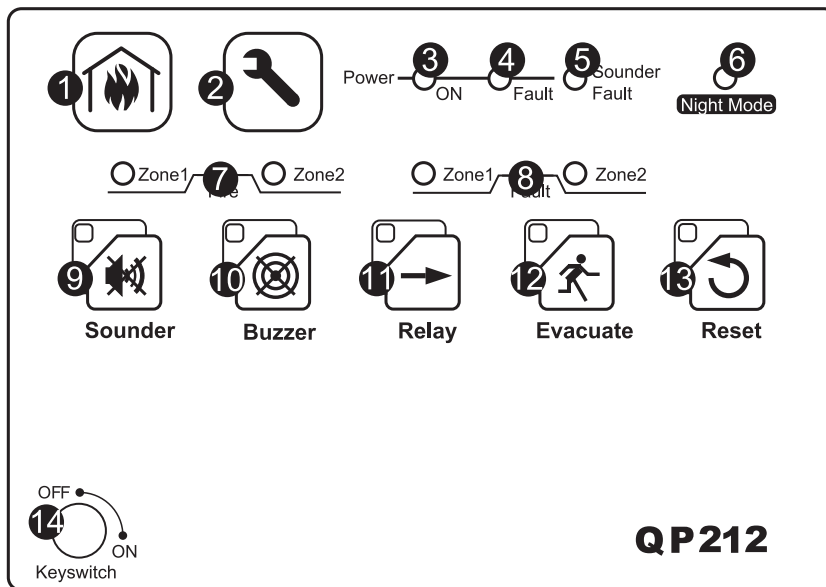
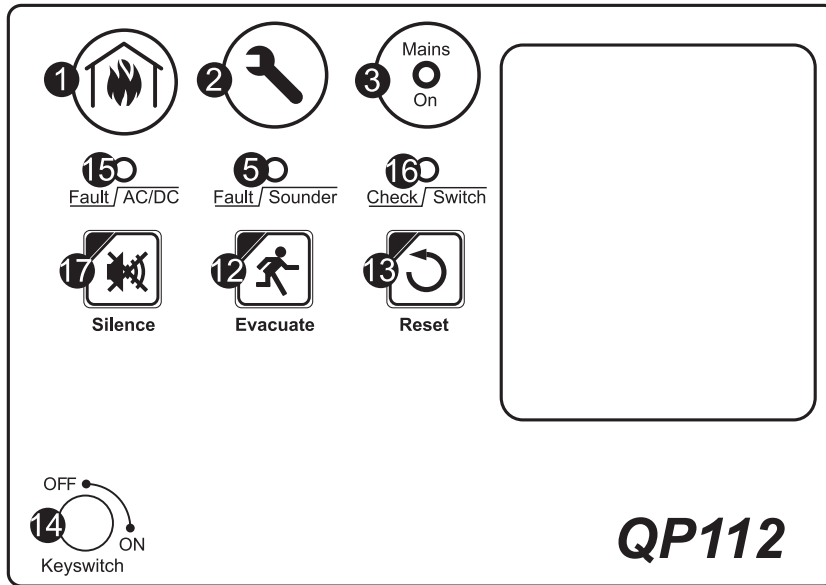

Descriptions

1. Fire Alarm Indicator : A red light indicates the Fire Alarm Control Panel has received a fire signal.
2. Fault Indicator : A yellow light indicates a fault in the fire alarm system.
3. Power ON : A green light indicates the Fire Alarm Control Panel is in normal condition.
4. Power Fault :
 - a. When the input alternating current supply has the breaking of contact malfunction, this lamp signal shines that is yellow light.
 - b. As Fire Alarm Control Panel's battery wire has short cut or when the breaking of contact shines the lamp signal that is flash yellow light.
5. Sounder Fault : A yellow light indicates a short circuit or wire-break to the sounder.
6. Night mode : When the "Night Mode" LED is light ON, it means panel is reconfirming the alarm signal from detector, LED light will OFF after 7 seconds confirmation. The panel will activate Fire condition if signal is confirmed.
7. Zone Alarm Indicator : A red light indicates the Fire Alarm Control Panel has received a fire signal from this zone.
8. Zone Fault Indicator : A steady yellow light indicates the Fire Alarm Control Panel has received a signal that a zone has short circuit or disconnection.
9. Sounder Switch :
 - a. (silence) When press switch once, LED ON and disable the sounder output.
 - b. (normal) When press switch twice, panel will back to normal status.
10. Buzzer Switch :
 - a. (temporary silence - LED steady ON) When press switch once, LED ON and disable the sounder output, any new incoming fire or fault signal will enable the buzzer and LED will OFF.
 - b. (long silence - LED flash) When press switch twice, LED flash and disable the buzzer output, any new incoming fire or fault signal will not enable the buzzer.
 - c. (normal) When press switch three times, panel will back to normal status.

Descriptions

11. Relay Switch : Pressing this switch will disable the fire and fault relay output.
12. Evacuate Switch : When presses down the switch the system will generate a panel alarm.
13. Reset Switch : Press this switch resets the panel, LED lights ON for 5 seconds and then return to normal status.
****Note : Reset will be allowed when all outputs have been silenced (QP112).**
14. Keyswitch : The keyswitch is enable or disable switch button.
15. Fault/AC/DC : When working voltage is supplied only by battery or AC power, the LED will light ON and buzzer will active.
16. Check/Switch : The light will ON When any switch is in use.
17. Silence Switch : Presses down this switch to silence the panel buzzer and sounder output.
18. AC Fault : A yellow light indicates a break in the AC power supply, the buzzer will sound as well.
19. DC Fault : A yellow light indicates battery has fault, the buzzer will sound as well.
20. Lamp Fault : A yellow light indicates Lamp output is faulty.
21. +24V AUX Fault :
 - a. light up when +24V AUX fault.
 - b. LED will flash at Resistor Mode.
22. Disable : Light up when any zone output is switch OFF.
23. Z1 、 Z2 、 Z3 、 Z4 :
 - a. Red LED ON when fire is detected.
 - b. Yellow LED ON when zone is open or short.
 - c. Red LED flashes when relay is OFF.
 - d. At Resistor Mode, the LED is ON when EOL resistor is connected.
24. Z1 、 Z2 、 Z3 、 Z4 switch :
 - a. Press this switch to disable output when fire is detected.
 - b. In Resistor Mode, press this switch to connect EOL resistor.

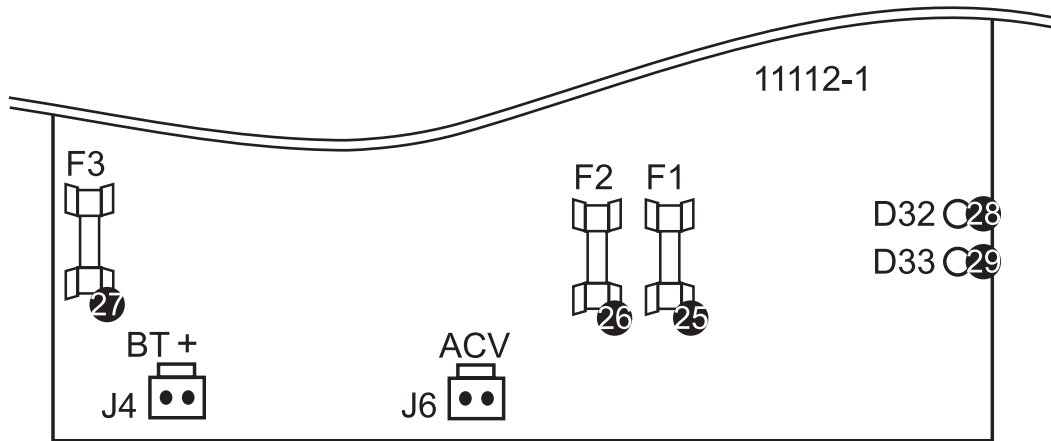

- 25. F1 : Sounder Output Fuse (1A)
- 26. F2 : Lamp(+24V Output) Fuse (1A)
- 27. F3 : DC Power Fuse (2A)
- 28. D32 : Zone Open LED
- 29. D33 : Zone Short LED

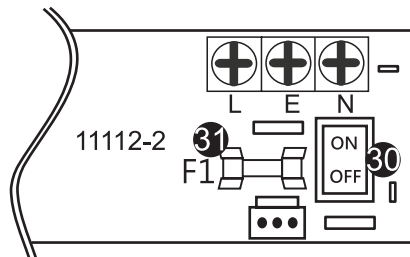

- 30. AC Power Switch
- 31. F1 : AC Power Fuse (2A)

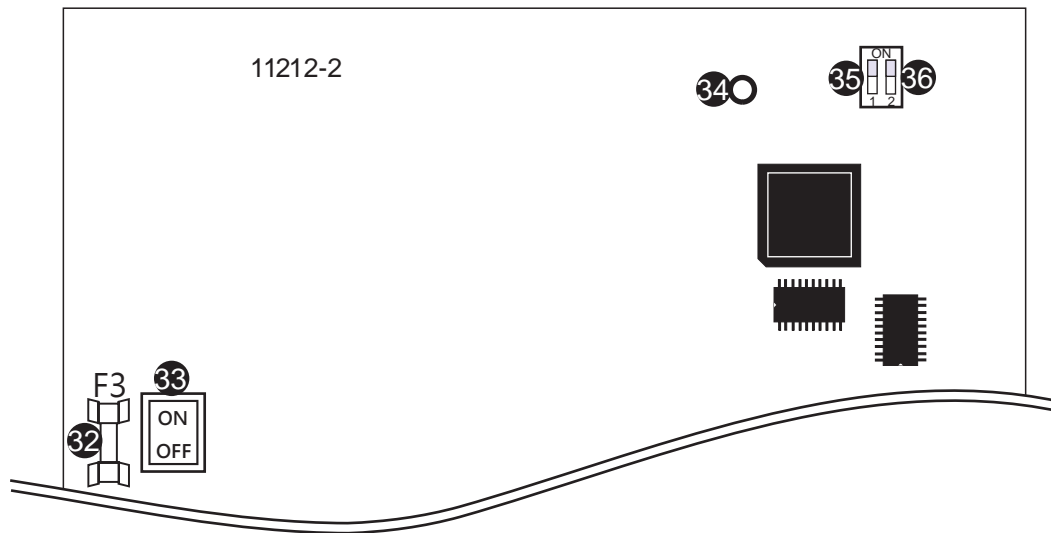

32. F3 : Battery Fuse (2A)

33. Battery Switch

34. Ground Fault Indicator :
When the input and the output contact line occurs with the cabinet or the earth has the short cut condition, lamp signal shines in this time that is yellow light.

35. Auto Reset DIP Switch :
When the switch to " 1 " position is under auto reset mode, this feature is for one man work test.

36. Nigh Mode DIP Switch :
When the switch to " 2 " position is under night mode.

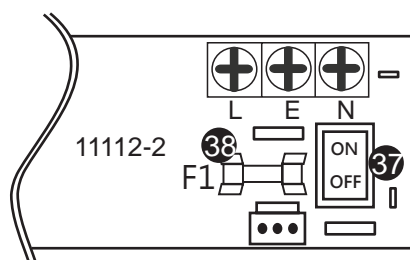

37. AC Power Switch

38. F1 : AC Power Fuse (2A)

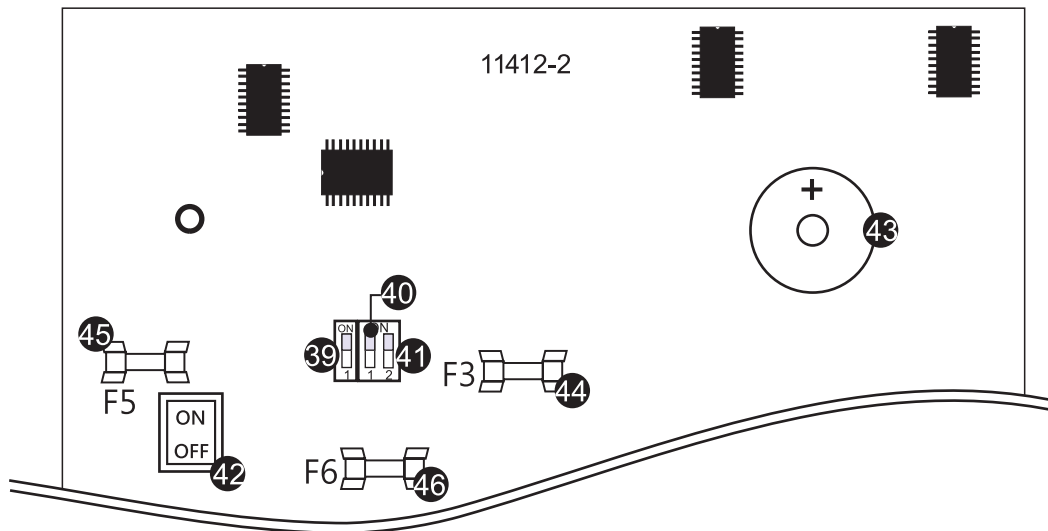

- 39. Resistor Mode :
Set the switch to ON, +24V AUX LED will flash. Press Z1 、 Z2 、 Z3 、 Z4 and Sounder will set internal EOL resistor with LED ON.
- 40. Day/Night Mode :
Set the switch to ON, the Night Mode LED will ON. When fire is detected, Night Mode LED will flash 5 seconds and then reset the panel. If fire still detected, the panel will issue alarm.
- 41. Auto Reset Mode :
Press it for detector resettable feature, panel will release fire alarm when signal is disappear.
- 42. Battery Switch
- 43. Buzzer :
Intermittent sound when fault, continuous sound when fire.
- 44. F3 : LAMP Fuse (2A)
- 45. F5 : Battery Power Fuse (2A)
- 46. F6 : +24V Fuse (2A)

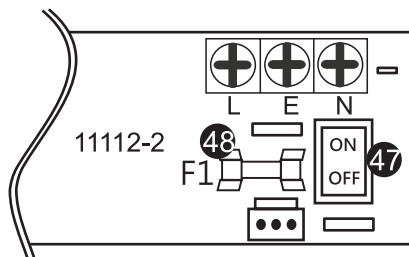

- 47. AC Power Switch
- 48. F1 : AC Power Fuse (2A)

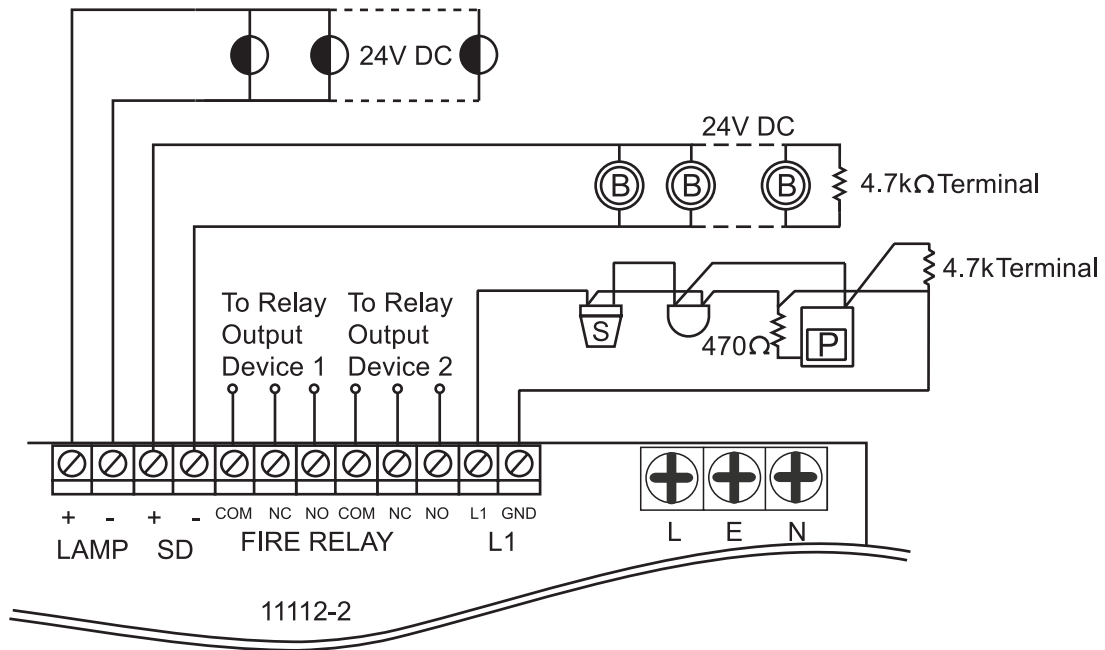

Typical wiring arrangements for detector and sounder circuits.

TYPICAL ZONE LOOP CIRCUIT

Call points wired before detectors - detector base diodes not needed

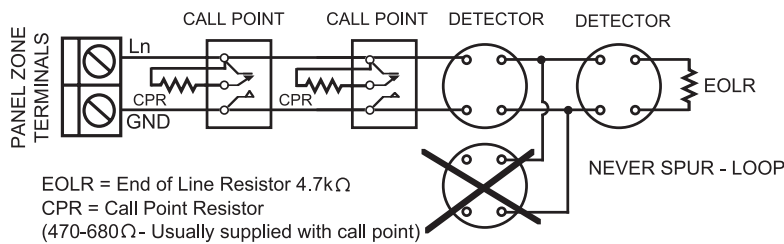

ZONE LOOP CIRCUIT - With mixed order call points and detectors (Detector bases fitted with continuity diodes, and negative connection linked out)

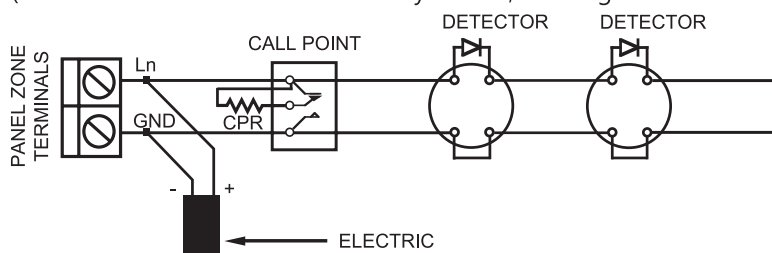

Method of Area Bell Wiring

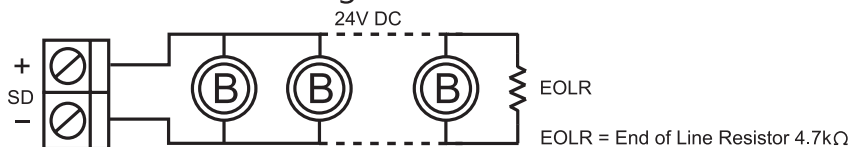

It is equipped with one set of Area Bells in the Control Panel, when wiring to sole group Area Bell wiring must pay attention in the terminal and connects the resistance in a terminal electricity group. In order to avoid the Area Bell have the malfunction, please install the resistance 4.7K ohm in the contact place when the area bell contact is not used.

Typical wiring arrangements for detector and sounder circuits.

TYPICAL ZONE LOOP CIRCUIT

Call points wired before detectors - detector base diodes not needed

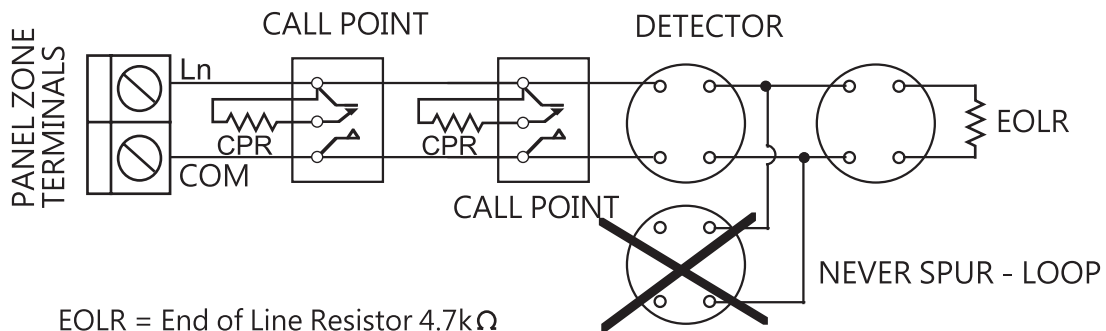

EOLR = End of Line Resistor $4.7k\Omega$
 CPR = Call Point Resistor
 (470-680 Ω - Usually supplied with call point)

ZONE LOOP CIRCUIT - With mixed order call points and detectors (Detector bases fitted with continuity diodes, and negative connection linked out)

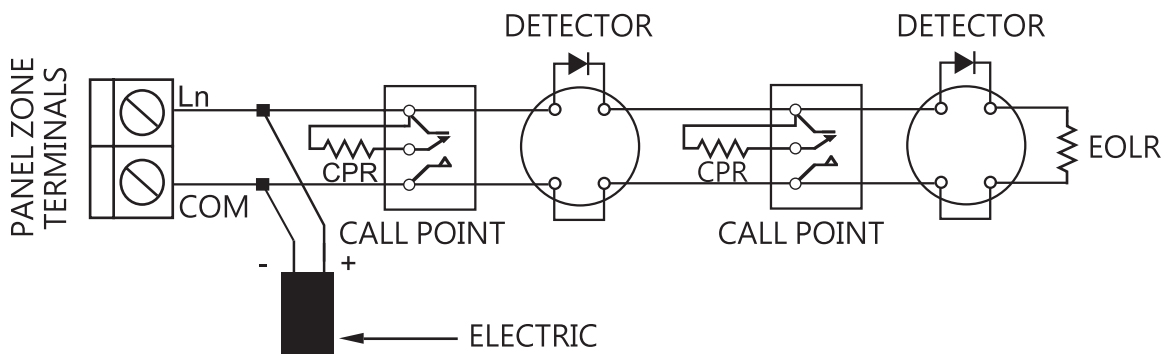

Method of Area Bell Wiring

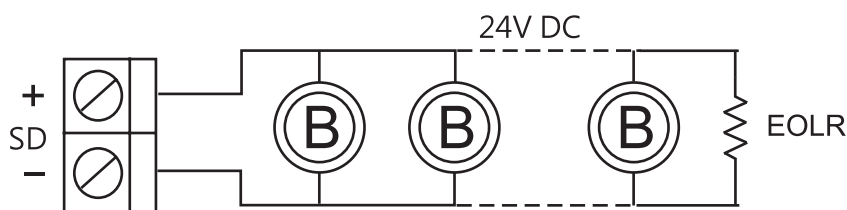

EOLR = End of Line Resistor $4.7k\Omega$

It is equipped with one set of Area Bells in the Control Panel, when wiring to sole group Area Bell wiring must pay attention in the terminal and connects the resistance in a terminal electricity group. In order to avoid the Area Bell have the malfunction, please install the resistance 4.7K ohm in the contact place when the area bell contact is not used.

PERMANENT MAINS / BATTERY FAULT

1. Check the MAINS ON light is lit. If not, check the mains supply and fuse (adjacent the transformer).
2. Check the battery supply (RED lead to BT+ terminal, BLACK lead to BT- terminal). If the battery leads have been connected the wrong way round the battery fuse (F3) will blow, however a permanent power fault may have been caused and CANNOT be reset.
3. Check 24 Volt batteries of the relevant size are connected in series.
4. Check the wiring is connected properly to 11112-1-J4.
5. Check the transformer leads are pushed on to the tags on the transformer properly.
6. If the MAINS ON & FAULT /AC/DC lights are still lit, the batteries are either over discharged or have failed - try a new pair, even new batteries can fail.

If the batteries are completely discharged or if they are inferior but still working, the battery fault circuit will still show a fault – check this using new batteries. Please note that a fully charged 24 Volt battery will measure 25 to 28 Volts.

A battery measuring less than 21 Volts that has been charged from the panel for more than 10 minutes is unlikely to recharge properly and should be replaced. The battery monitoring circuit will show a FAULT /AC/DC, which, if it does not cease, means that the batteries are faulty.

If good but completely discharged cells are used the FAULT /AC/DC light may stay on for several minutes until the battery obtains sufficient charge.

MANUAL CALL POINTS, HEAT DETECTORS, OR SMOKE DETECTORS TRIGGER, BUT DON'T CAUSE A FIRE CONDITION.

Either the wrong value call point resistor has been fitted in series at the call point or detector or a resistor is already fitted inside . If you have fitted a resistor try shorting it out and re-testing the device. Check the panel is OK, by removing the detector wiring and then re-inserting the End of Line Resistor into the terminals to give a normal condition. Then simulate a fire condition on the zone with a 470 to 680 Ohm resistor. If the zone goes into fire the device under test may be out of specification.

RESET BUTTON DOESN'T RESET THE PANEL FROM FIRE CONDITION

Press SILENCE first.

RESET BUTTON STILL DOESN'T RESET THE PANEL (PERMANENT FIRE CONDITION)

Either a call point is triggered in which case replace the glass or if an older bi-metal heat detector has triggered, wait for it to cool down and reset itself. Alternatively a smoke detector may be faulty and will not unlatch, in which case the LED on the detector may not be lit, or a call point may have failed in the triggered state. If you suspect a faulty device then you can only find it by following logical tests. Start by removing the wiring at the panel and refitting the End of Line Device (EOLD) to prove the panel is OK. Reconnect the wiring and replace the EOLD on the last device. Then starting at the end of the line, remove each detector in turn, then press Silence then Reset. When you reach the faulty device the panel will remain reset.

PERMANENT ZONE FAULT

Disconnect the zone completely and refit the End of Line Device (EOLD) at the panel. If the fault condition clears then there is a wiring fault. Double check and refit the wiring and EOLD on the zone and trace the fault with consideration for the type of fault indicated by the internal Fault leds (11112-1-D32,11112-1-D33).

A common fault is a detector badly seated in a base, which has not properly made connection. This will show as an open circuit Fault.

PERMANENT SOUNDER FAULT

Check the Sounder fuses (11112-1-F2) on the pcb have not blown and replace if necessary. If either fuse is blown a sounder fault will show. Check the correct End of Line Resistors have been fitted. Disconnect the relevant zone from the terminal block refit the end of line resistor only. If the fault condition clears there is a wiring fault. Note that the sounders must be polarised.

BUTTONS DON'T WORK

Turn the keyswitch to ON controls and press SILENCE and then RESET. If the fault persists, check the connection from the keyswitch is seated correctly on pcb plug (11112-1-J3).

PERMANENT MAINS / BATTERY FAULT

1. Check the Power Fault light. If the LED steady ON, check the mains supply AC power switch (11212-1-SW1/11412-1-SW1) and fuse (1112-2-F1 : adjacent the ON-OFF Switch).
2. Check the Power Fault light is lit. If the light is flash, check the battery power switch (11212-1-SW10/11412-1-SW10) and battery supply (RED lead to BT + terminal, BLACK lead to BT - terminal). If the battery leads have been connected the wrong way round the battery fuse (11212-1-F3/11412-1-F5) will blow, however a permanent power fault may have been caused and CANNOT be reset.
3. Check 24 Volt batteries of the relevant size are connected in series.
4. Check the wiring is connected properly to 11212-1-JP18/11412-1-T6.
5. Check the transformer leads are pushed on to the tags on the transformer properly.
6. If the Fault & Power FAULT lights are still lit and flash, the batteries are either over discharged or have failed - try a new pair, even new batteries can fail.

If the batteries are completely discharged or if they are inferior but will still working, the battery fault circuit will still show a fault – check this using new batteries. Please note that a fully charged 24 Volt battery will measure 25 to 28 Volts.

A battery measuring less than 21 Volts that has been charged from the panel for more than 10 minutes is unlikely to recharge properly and should be replaced. The battery monitoring circuit will show a Power Fault, which, if it does not cease, means that the batteries are faulty.

If good but completely discharged cells are used, the Power Fault light will still flash for several minutes until the battery obtains sufficient charge.

MANUAL CALL POINTS, DETECTORS TRIGGER, BUT DON'T CAUSE A FIRE CONDITION.

Either the wrong value call point resistor has been fitted in series at the call point or detector or a resistor is already fitted inside. If you have fitted a resistor try shorting it out and re-testing the device. Check the panel is OK, by removing the detector wiring and then re-inserting the End of Line Resistor into the terminals to give a normal condition. Then simulate a fire condition on the zone with a 470 to 680 Ohm resistor. If the zone goes into fire the device under test may be out of specification.

RESET BUTTON STILL DOESN'T RESET THE PANEL (PERMANENT FIRE CONDITION)

Either a call point is triggered in which case replace the glass or if an older bi-metal heat detector has triggered, wait for it to cool down and reset itself. Alternatively a smoke detector may be faulty and will not unlatch, in which case the LED on the detector may not be lit, or a call point may have failed in the triggered state. If you suspect a faulty device then you can only find it by following logical tests. Start by removing the wiring at the panel and refitting the End of Line Device (EOLD) to prove the panel is OK. Reconnect the wiring and replace the EOLD on the last device. Then starting at the end of the line, remove each detector in turn, then press Silence then Reset. When you reach the faulty device the panel will remain reset.

PERMANENT ZONE FAULT

Disconnect the zone completely and refit the End of Line Device (EOLD) at the panel. A common fault is a detector has not properly connected with base.

GROUND FAULT

Check the PCB 11412-D18 light. If the LED steady ON, Check the input and the output contact line occurs with the cabinet or the earth has the short cut condition.

PERMANENT SOUNDER FAULT

Check the Sounder Fault light is lit. If the LED steady ON, check the correct End of Line Resistors have been fitted. Disconnect the relevant zone from the terminal block and refit the end of line resistor only. If the fault condition clears there is a wiring fault. Note that the sounders must be polarised.

BUTTONS DON'T WORK

Turn the keyswitch to ON controls and press any switch. If the fault persists, check the connection from the keyswitch is seated correctly on pcb plug 11212-SW12/11412-SW25.

Panel Specifications

POWER SPECIFICATION	
MAINS SUPPLY VOLTAGE	220Va.c.±10% 50/60 Hz
INTERNAL POWER SUPPLY	27Vd.c. Nominal
TOTAL OUTPUT CRURRENT LIMITED TO (@24Vdc)	QP112 : 1.0A QP212 : 1.2A QP412 : 2.0A
AUXILIARY POWER OUTPUT	27Vd.c. Nominal
MAINS SUPPLY MONITORED FOR FAILURE	Yes
BATTERY CHARGE MONITORED FOR FAILURE	Yes
BATTERY MONITORED FOR DISCONNECTION AND FAILURE	Yes
DETECTOR CIRCUIT SPECIFIATION	
NUMBER OF CIRCUITS	1
LINE FAULT MONITORED FOR OPEN CIRCUIT	Yes
LINE FAULT MONITORED FOR SHORT CIRCUIT	Yes (Can be disable)
LINE FAULT MONITORED FOR DETECTOR REMOVAL	Yes, if End of Line Monitor Unit fitted in place of End of Line Resistor
END OF LINE DEVICE	4.7kΩ, 5% Tolerance, 0.25W (Colour code : Yellow, Purple, Red, Gold)
DETECTOR CONTINUITY DIODES	Silicon 1N4001 or Schottky type
CALL POINT RESISTOR VALUE	470Ω to 680Ω , 0.25Watt or 0.5Watt
MAXIMUM NUMBER OF SMOKE/HEAT DETECTORS PER ZONE	20 (based on a total detector current of 2mA, each detector consuming 100uA). (note : If end of line monitoring unit is fitted, for correct operation maximum voltage drop must not exceed 12 volts.)
MAXIMUM NUMBER OF MANUAL CALL POINTS PER ZONE	No limit
SOUNDER CIRCUIT SPECIFICATION	
NUMBER OF CIRCUITS	1
END OF LINE RESISTOR VALUE	4.7kΩ, 5% Tolerance, 0.25W (Colour code : Yellow, Purple, Red, Gold)
LINE FAULT MONITORED FOR OPEN AND SHORT CIRCUIT	Yes
OUTPUTS FUSED AT	1A
FUSES	FUSES
MAIN TERMINAL BLOCK, PCB #11112-2:F1	2.0A T 20mm
SOUNDER OUTPUTS, PCB #11112-1:F1(QP112)	1.0A F 20mm
LAMP +24V OUTPUTS, PCB #11112-1:F2(QP112)	1.0A F 20mm
LAMP +24V OUTPUTS, PCB #11212-1:F4(QP212)	1.0A F 20mm
LAMP +24V OUTPUTS, PCB #11412-1:F3(QP412)	2.0A T 20mm
BATTERY FUSE, PCB #11112-1:F3(QP112)	2.0A F 20mm
BATTERY FUSE, PCB #11212-1:F3(QP212)	2.0A F 20mm
BATTERY FUSE, PCB #11412-1:F5(QP412)	2.0A F 20mm
+24V VOLTAGE OUTPUT PCB #11412-1:F6(QP412)	2.0A T 20mm
DIMENSIONS	DIMENSIONS
ENCLOSURE (WIDTH x HEIGHT x DEPTH)	273 x 203 x 72 mm
BATTERY VOLUME DIMENSIONS (WIDTH x HEIGHT x DEPTH)	195 x 43 x 60 mm (Will accept typical 1.2 or 2.0 Ah Sealed lead acid batteries.)
WEIGHT (WITHOUT BATTERIES)	About 2.5 Kg



QP Family
Fire Alarm Control Panel

HORING LIH INDUSTRIAL CO., LTD.